

SAMSUNG

THREE-CD CHANGER
VIDEO-CD
MINI-COMPACT SYSTEM
MP3-CD/CD-R/RW PLAYBACK
MAX-VS530

Instruction Manual

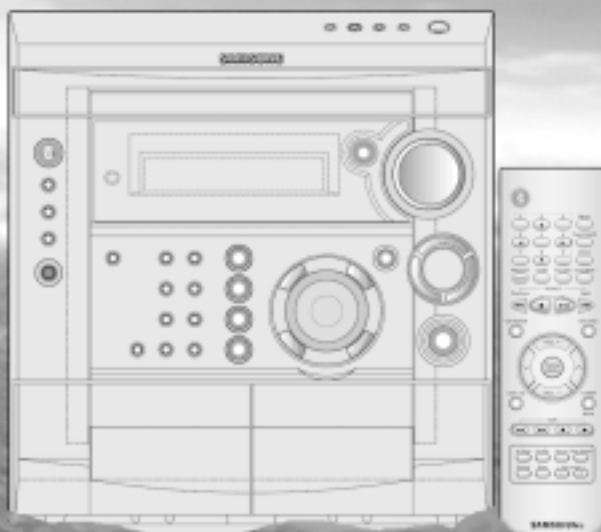

Safety Warnings

GB

CLASS 1 LASER PRODUCT
KLASSE 1 LASER PRODUKT
LUOKAN 1 LASER LAITE
KLASS 1 LASER APPARAT
PRODUCTO LASER CLASE 1

CLASS 1 LASER PRODUCT

This Compact Disc player is classified as a CLASS 1 LASER product.

Use of controls, adjustments or performance of procedures other than those specified herein may result in hazardous radiation exposure.

CAUTION-INVISIBLE LASER RADIATION WHEN OPEN AND INTERLOCKS DEFEATED, AVOID EXPOSURE TO BEAM.

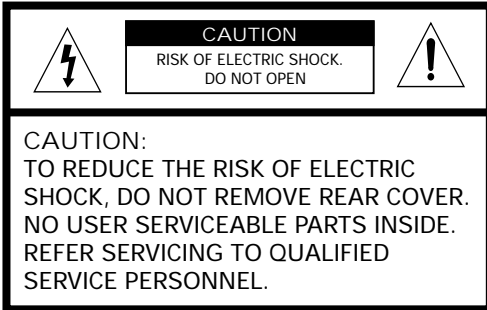

This symbol indicates that dangerous voltage which can cause electric shock is present inside this unit.



This symbol alerts you to important operating and maintenance instructions accompanying the unit.

WARNING: To reduce the risk of fire or electric shock, do not expose this appliance to rain or moisture.

CAUTION: TO PREVENT ELECTRIC SHOCK, MATCH WIDE BLADE OF PLUG TO WIDE SLOT, FULLY INSERT.

- ◆ **SAFETY WARNINGS** 2
- ◆ **INSTALLING YOUR MINI-COMPACT SYSTEM**
- Front Panel View 4
- Remote Control 5
- Rear Panel View 6
- Where to Install Your Mini-Compact System 7
- Connecting your System to the Power Supply 7
- Inserting Remote Control Batteries 7
- Connecting to an External Source 8
- Connecting the Loudspeakers 8
- Connecting the AM (MW)/LW Aerial 9
- Connecting the FM Aerial 9
- Connecting the SW Aerial(Option) 9
- Connecting the equipment 9
- Demo/Dimmer function 10
- Setting the Clock 10
- ◆ **VCD/CD-PLAYER**
- Loading and Changing Compact Discs 11
- To replay the CD/MP3-CD 11
- Selecting a CD in the Disc changer 12
- MP3-CD Playback 12
- Selecting a Track 13
- Searching for a Specific Music Passage on a CD 13
- Function to skip through 10 tracks at a time 13
- Shuffle Play Function 14
- Repeating One or All Tracks on the Compact Discs 14
- Programming the Order of Playback 15
- Checking or Changing Programmed Tracks 15
- Video CD Player Playback 16
- Search Functions 16
- Time Search Functions 16
- When adjusting play speed 17
- NTSC/PAL Selection Method 17
- Sound Select Function 17
- KEY CONTROL Function 17
- VCD View Function 18
- ZOOM Function 18
- Last Memory Function 18
- ◆ **TUNER**
- Searching for and Storing the Radio Stations 19
- Selecting a Stored Station 19
- Improving Radio Reception 19
- ◆ **TAPE DECK**
- Listening to a Cassette 20
- CD Synchro Record Feature 20
- Recording a Compact Disc 20
- Recording a Radio Programme 21
- Copying a Cassette (Dubbing) 21
- Selecting the Cassette Playback Mode (Deck 2 Only) 21
- ◆ **OTHER FUNCTIONS**
- Timer Function 22
- Cancelling the Timer 22
- Mute Function 23
- Selecting an Equalizer Preset 23
- How to adjust USER EQ? 23
- Power Sound Function 23
- Setting the System to Switch off Automatically 24
- Super Bass Sound 24
- Connecting Headphones 24
- Microphone Function 24
- ◆ **RECOMMENDATIONS FOR USE**
- Safety Precautions 25
- Cleaning Your Mini-Compact System 25
- Precautions When Using Compact Discs 26
- Precautions When Using Audio Cassettes 26
- Before Contacting the After-Sales Service 26
- Technical Specifications 27



Symbols



Front Panel View

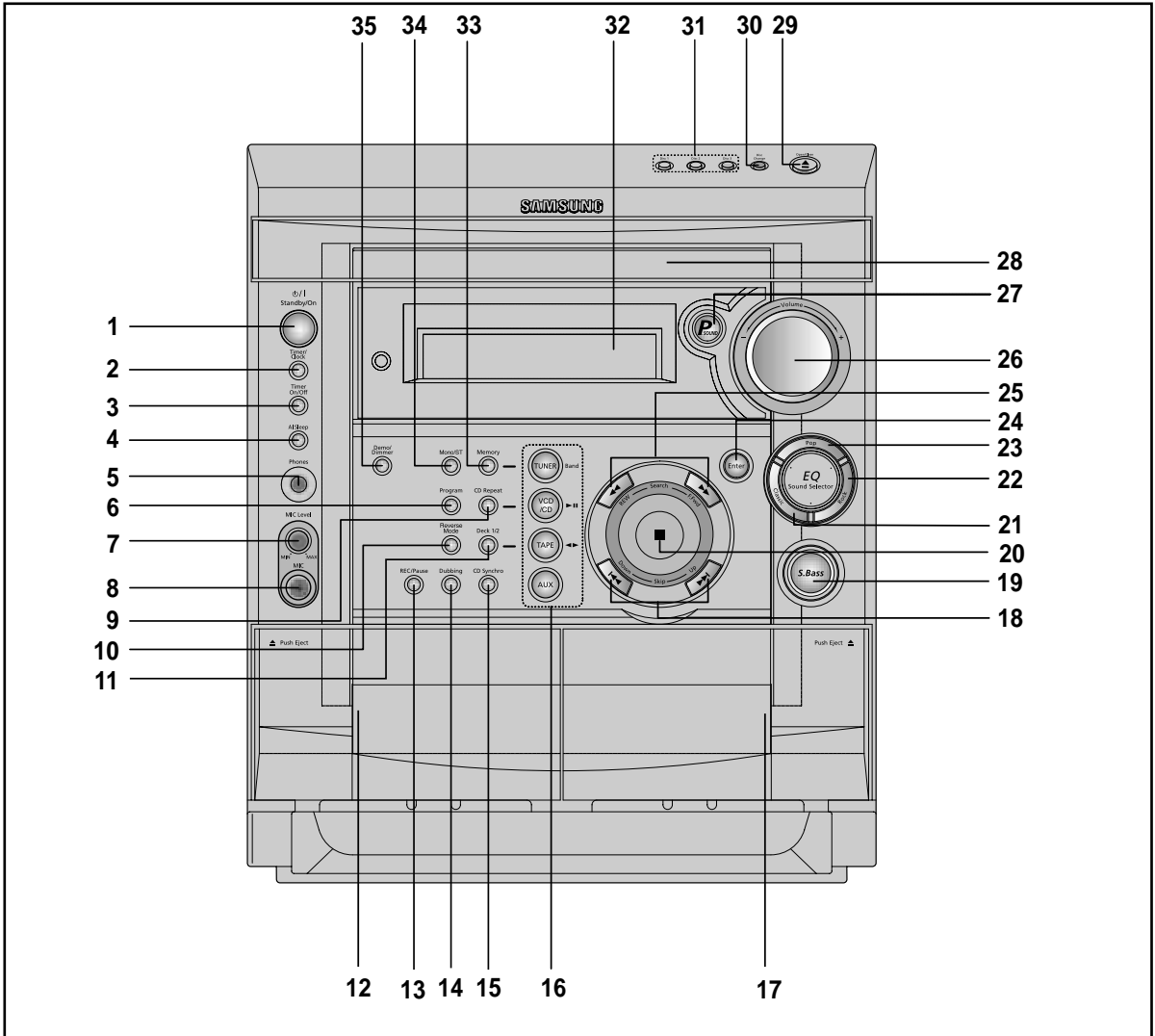

- | | |
|--------------------------------|------------------------------|
| 1. Standby/On | 19. Super.Bass |
| 2. Timer/Clock | 20. Stop button |
| 3. Timer On/Off | 21. EQ Preset Classic |
| 4. AI Sleep | 22. EQ Preset Rock |
| 5. Headphone Jack Connector | 23. EQ Preset Pop |
| 6. Program button | 24. Enter |
| 7. MIC Level (option) | 25. Search Function buttons |
| 8. MIC Jack(option) | 26. Volume |
| 9. CD Repeat | 27. Power Sound |
| 10. Reverse Mode | 28. Compact Disc Compartment |
| 11. Deck 1/2 | 29. CD Open/Close |
| 12. Cassette Deck 1 | 30. Disc Change |
| 13. Record/Pause | 31. Disc Selection buttons |
| 14. TAPE Normal Dubbing | 32. Window Display |
| 15. CD Synchro Recording | 33. Memory Function |
| 16. Function Selection buttons | 34. Mono/Stereo |
| 17. Cassette Deck 2 | 35. Demo/Dimmer |
| 18. Skip Function buttons | |

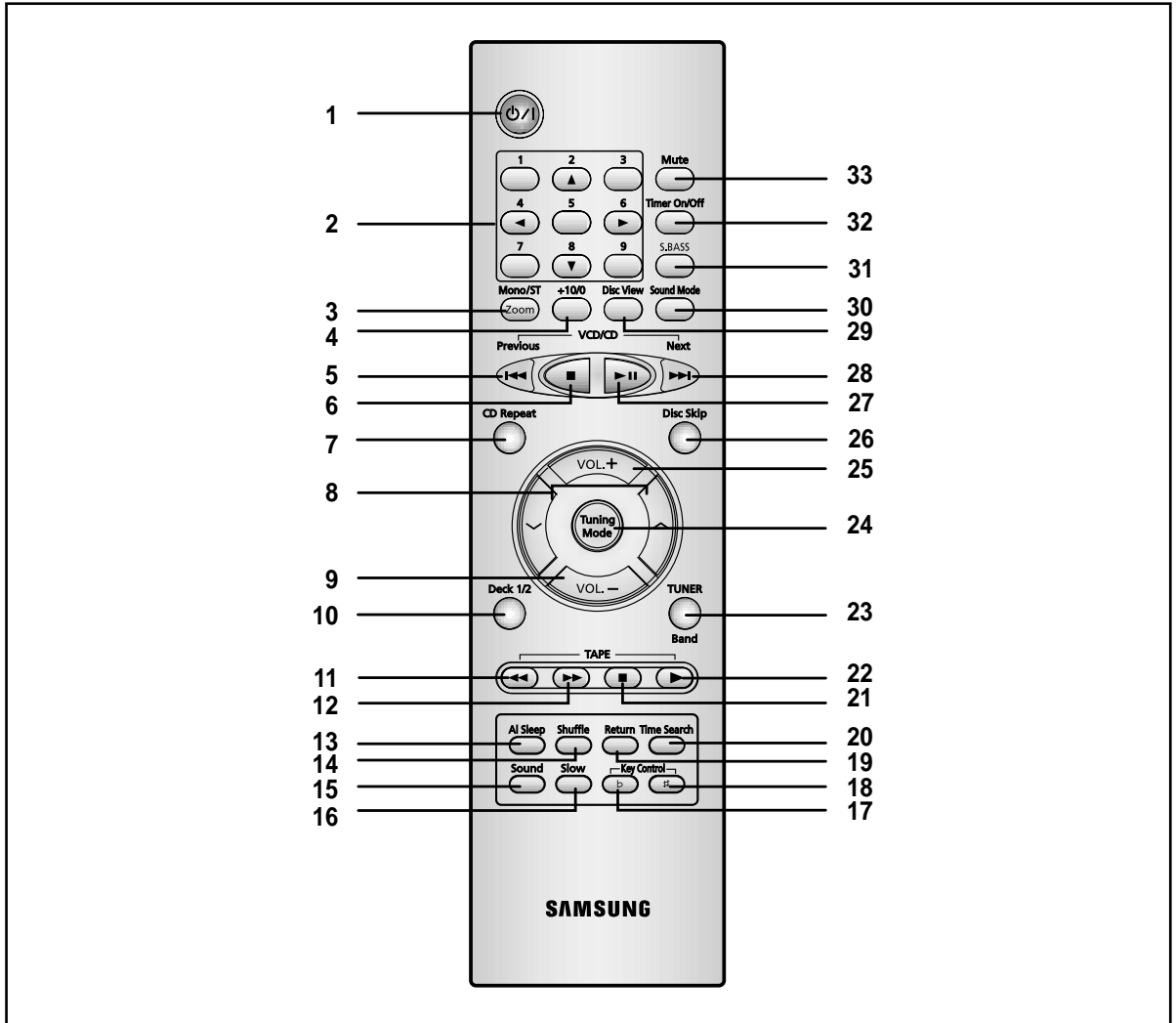

- | | |
|--|-------------------------------|
| 1. Standby/On | 18. Key Control # |
| 2. Digit Buttons/Direction Buttons | 19. Return |
| 3. FM Mono/Stereo/ VCD Zoom | 20. Time Search (Last Memory) |
| 4. +10/0 | 21. TAPE Stop |
| 5. Track Previous | 22. TAPE Play |
| 6. VCD/CD Stop | 23. Tuner/Band |
| 7. CD Repeat | 24. Tuning Mode |
| 8. Radio Station Search | 25. Volume Increase |
| 9. Volume Decrease | 26. Disc Number Skip |
| 10. Deck 1/2 | 27. Disc Play/Pause |
| 11. TAPE Rewind | 28. Track Next |
| 12. TAPE Fast-Forward | 29. Disc View |
| 13. AI Sleep | 30. Sound Mode |
| 14. VCD/CD Shuffle Play/MP3-CD Random Play | 31. Super.Bass |
| 15. VCD Sound | 32. Timer On/Off |
| 16. VCD Slow Play | 33. Mute |
| 17. Key Control b | |

Rear Panel View

GB

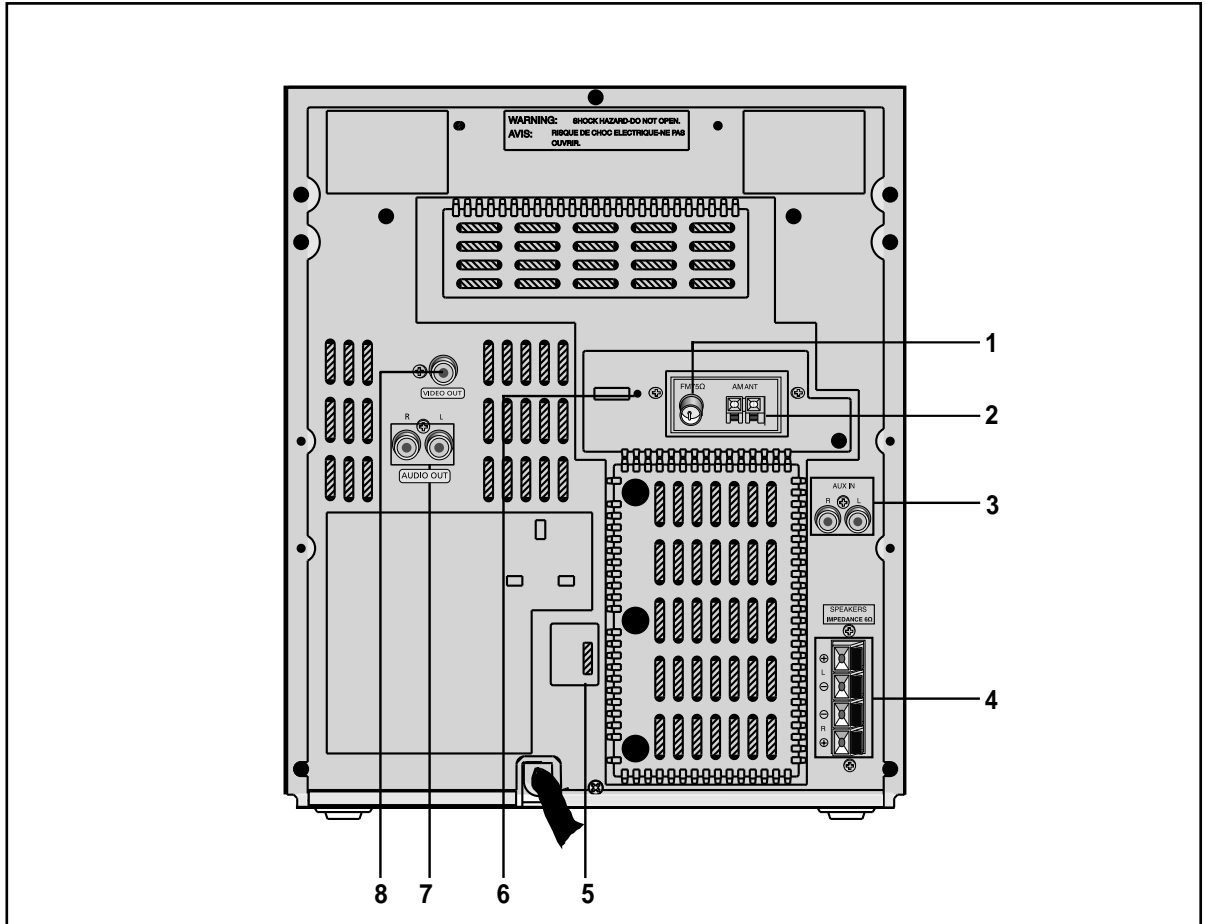

1. FM Aerial Connector Terminal
2. AM Aerial Connector Terminals
3. AUX-Input
4. Loudspeaker Connector Terminals
5. Voltage Selector(option)
6. SW Aerial Connector Terminal(option)
7. Audio (DISC) Output
8. Video (DISC) Output

Where to Install Your Mini-Compact System

To take full advantage of your new mini-compact system, follow these installation instructions before connecting the unit.

- ◆ Install the system on a flat, stable surface.
- ◆ Never place this unit on carpeting.
- ◆ Never place this unit in an outdoor area.
- ◆ Maintain an open space of approximately 6 inches (15 cm) on the sides and rear of the system, for ventilation purposes.
- ◆ Make sure that you have enough room to open the compact disc compartment easily.
- ◆ Place the loudspeakers at a reasonable distance on either side of the system to ensure good stereo sound.
- ◆ Direct the loudspeakers towards the listening area.
- ◆ For optimum performance, make sure that both speakers are placed at an equal distance above the floor.

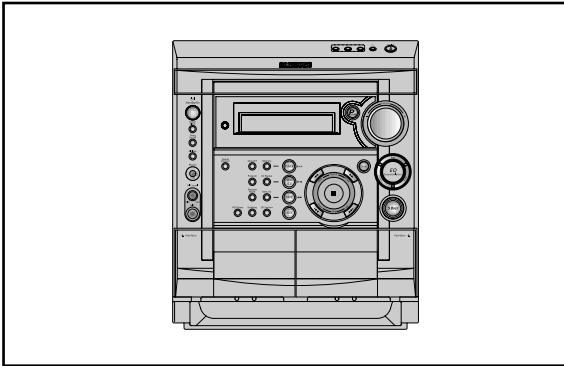

Connecting your System to the Power Supply

The main lead must be plugged into an appropriate socket.

- ☛ Before plugging your system into a main socket, you must check the voltage.

- 1 Check the position of the voltage selector on the rear of the system (OPTIONAL).
- 2 Plug the main lead (marked **AC Cord** on the rear of the system) into an appropriate socket.
- 3 Press the **Standby/On** button to switch your mini-compact system on.

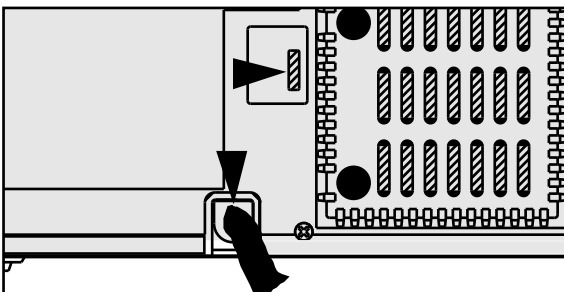

Inserting Remote Control Batteries

Insert or replace remote control batteries when you:

- ◆ Purchase the mini-compact system
- ◆ Find that the remote control is no longer operating correctly

- ☛ When replacing the batteries, use a new set of batteries and never mix alkaline and manganese batteries.

- 1 Place your thumb on the position marked  on the battery compartment cover (rear of the remote control) and push the cover in the direction of the arrow.
- 2 Insert two AA, LR6 or equivalent batteries, taking care to respect the polarities:
 - ◆ + on the battery against + in the battery compartment
 - ◆ - on the battery against - in the battery compartment
- 3 Replace the cover by sliding it back until it clicks into position.

- If you will not be using the remote control for a long time, remove the batteries to prevent corrosion.

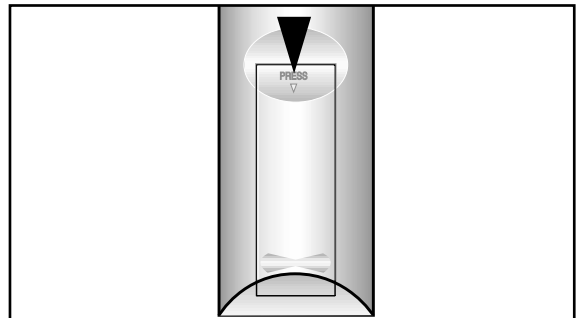

Connecting to an External Source

GB

The auxiliary input can be used to take advantage of the sound quality of your mini-compact system when listening to other sources.

- Examples:**
- ◆ A television
 - ◆ A video disc player
 - ◆ A Hi-Fi stereo video cassette recorder

➤ To connect the external source, the source must have an audio output. In addition, you need an RCA connection cable.

- 1 Set the system to standby mode and disconnect it and the external source from the main.
- 2 Connect the audio cable to the rear of the mini-compact system.

Connect the...	To the connector marked...
Red jack	R (right)
White jack	L (left)

➤ For optimum sound quality, do not invert the right and left channels.
- 3 Plug the system back into the main socket and press **Standby/On** to switch it on.
- 4 Select the AUX source by pressing **AUX**.
Result: **AUX** is displayed.
- 5 Switch the external source on.
- 6 Adjust the volume and balance as required:
 - ◆ Volume
 - ◆ Equalizer

Example: You can watch a film and take advantage of stereo sound provided that the original sound track is in stereo (as if you were in a cinema).

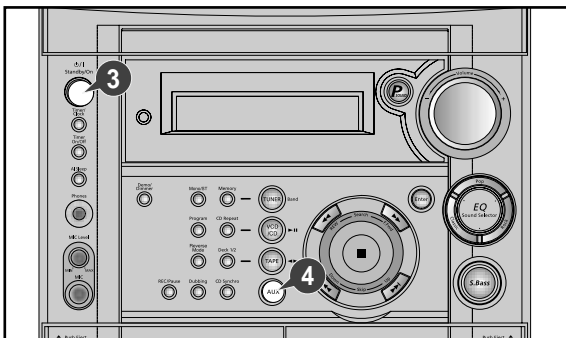
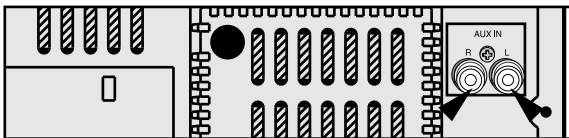

Connecting the Loudspeakers

The loudspeaker connector terminals are located on the rear of the system.

- 1 Press and hold the terminal tab.
- 2 Insert the speaker cord.
- 3 Release the finger.

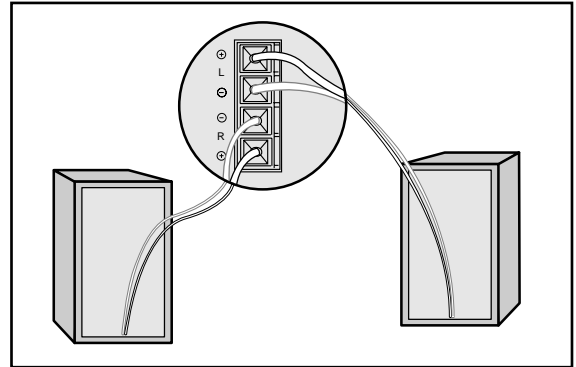

Directions in Installing Speaker

- ◆ Installation in a place near heating apparatus, under direct lay of light or with high humidity may cause performance degradation of the speaker.
- ◆ Do not install on the wall or on a high place of pole or other unstable place to prevent any safety accident caused by falling of the speaker.
- ◆ Do not take the speaker apart from TV or computer monitor. The speaker near the TV or computer monitor may influence the quality of the screen display.

Connecting the AM (MW)/LW Aerial

The AM aerial (for long and medium waves) can be:

- ◆ Placed on a stable surface
- ◆ Fixed to the wall (you must first remove the base)

The AM aerial connector terminals are located on the rear of the system and are marked AM.

To avoid noise interference, check that the loudspeaker wires do not run close to the aerial wires. Always keep them at least 2 inches (5 cm) away.

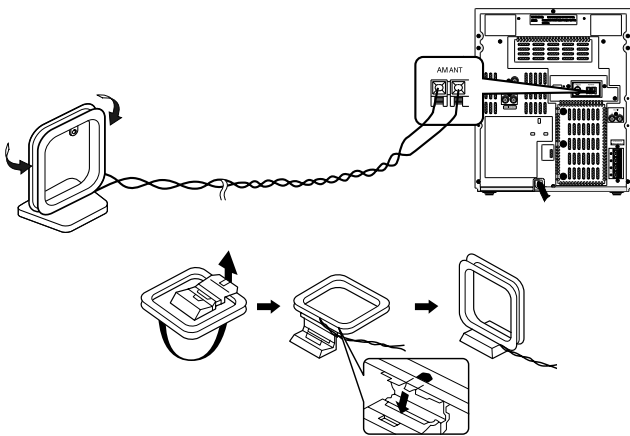

Connecting the FM Aerial

How to connect a COAXIAL TYPE aerial.

- ◆ Connect a 75Ω antenna to the FM antenna terminal.
- ◆ Plug the connector on the FM aerial supplied into the coaxial socket (75Ω) marked FM on the rear of the system.
- ◆ Follow the instructions given on Page 19 to tune into a radio station, and determine the best position for the aerial.
- ◆ If reception is poor, you may need to install an outdoor aerial. To do so, connect an outdoor FM aerial to the FM socket on the rear of the system using a 75Ω coaxial cable (not supplied).

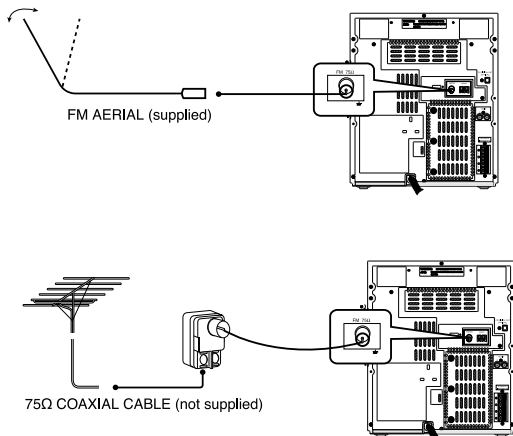

Connecting the SW Aerial (option)

How to connect a WIRE TYPE aerial.

- ◆ Spread the SW aerial out and attach the ends to a wall, in the position providing the best reception.
- ◆ If reception is poor (e.g. distance from transmitter too great, walls blocking the radio waves, etc.), install an outdoor aerial.

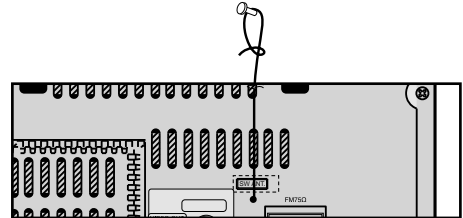

Connecting to the Equipment

- ◆ Using the Audio Cord, Connect the Audio Output Terminals (Left, Right) of the System with the Audio Input Terminals (Left, Right) of the Video Input Cassette Recorder, so as to Record VCD.
- ◆ Using the Video Cord, Connect the Video Output Terminal of the system with the Video Input Terminal of TV.
- ◆ Turn on the TV and Select the Video mode by pressing the TV/VIDEO SELECT button to the VIDEO Position.

Please Pay Attention not to Connect the Audio Output Terminals (left, right) of the System with the Audio Input Terminal of TV.

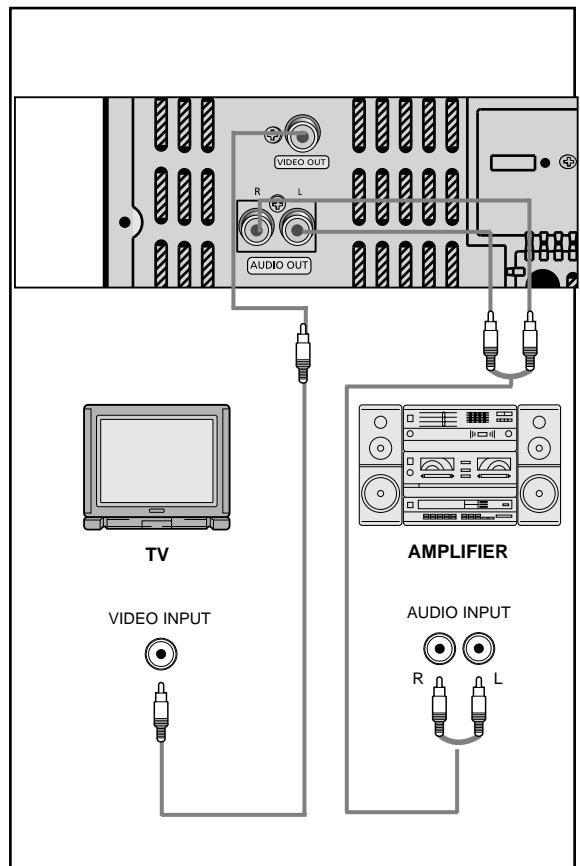

Demo/Dimmer Function

GB

All functions available on the system can be viewed on the display and the display's brightness can be switched between "on" and "off".

- 1 Press the **Demo/Dimmer** button.
Result: All functions available on the system appear on the front panel display.
- Each of these are explained in detail in this guide. Please refer to the relevant section.
- 2 Press the **Demo/Dimmer** button again.
Result: The Dimmer function is selected and the display darkens.
- Press the **Demo/Dimmer** button once again to brighten the front panel display.
- 3 A display brightness control can only be performed while the system power is on.

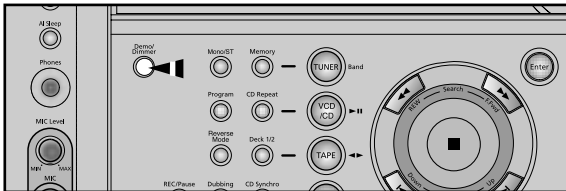

Setting the Clock

Your system is equipped with a clock which allows you to turn your system on and off automatically. You should set the clock:

- ◆ When you purchase the mini-compact system
- ◆ After a power failure
- ◆ After unplugging the unit
- ◆ Remember to reset the time when the clock changes from winter to summer time and vice versa.
- ◆ For each step, you have a few seconds to set the required options. If you exceed this time, you must start again.

- 1 Switch the system on by pressing **Standby/on**.
- 2 Press **Timer/Clock** twice.
Result: **CLOCK** is displayed.
- 3 Press **Enter**.
Result: The hour flashes.
- 4

To...	Press the...
Increase the hours	▶▶
Decrease the hours	◀◀
- 5 When the correct hour is displayed, press **Enter**.
Result: The minutes flash.
- 6

To...	Press the...
Increase the minutes	▶▶
Decrease the minutes	◀◀
- 7 When the correct time is displayed, press **Enter**.
Result: The clock starts and is displayed, even when the system is in standby mode.

- ◆ You can display the time, even when you are using another function, by pressing **Timer/Clock** once.

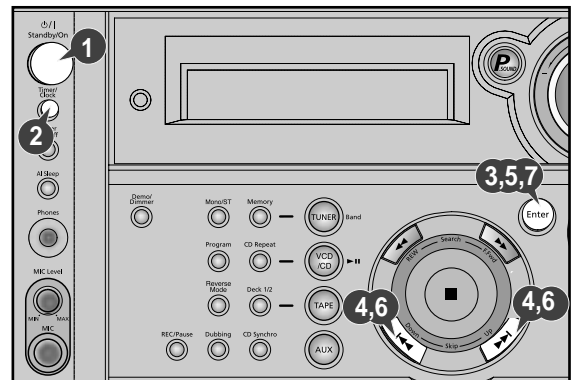

Loading and Changing Compact Discs

The CD disc changer can contain up to three 12 cm or 8 cm compact discs without using an adapter.

⚠ Never force the compact disc carousel when opening and closing the compartment.

Never press down or place objects on the carousel.

➤ Always treat your compact discs with care; refer, if necessary, to the section entitled "Precautions When Using Compact Discs" on page 26.

- 1 Switch the system on by pressing **Standby/On**.
- 2 Press the **Open/Close** (▲) button on the front panel.
Result: The compartment opens.
- 3 Place one or two discs in the front slots of the carousel, with the label on the discs facing upwards.
⚠ Check that the compact disc has been correctly inserted in the holder before closing the compartment.
- 4 If you wish to load a third compact disc, press the **Disc Change** button on the front panel (or **Disc Skip** on the remote control).
Result: The carousel rotates by 120°.
- 5 Close the compartment by pressing the **Open/Close** (▲) button again.
➤ If you wish to start playing a disc directly, you can also proceed as follows.

To play...	Press...
Disc 1	VCD/CD (▶) or Disc 1
Disc 2	Disc 2
Disc 3	Disc 3

Result: The compartment closes automatically and the disc selected starts playing.

- 6 To change or unload the compact disc changer, repeat Steps 2 to 5.

⚠ Keep the compartment closed whenever you are not using it, to prevent dust from entering.

➤ ♦ You can load or unload compact discs when the radio, tape or auxiliary source function is selected.

♦ The function will be automatically entered VCD/CD from the other source when you press **CD Open/Close** button.

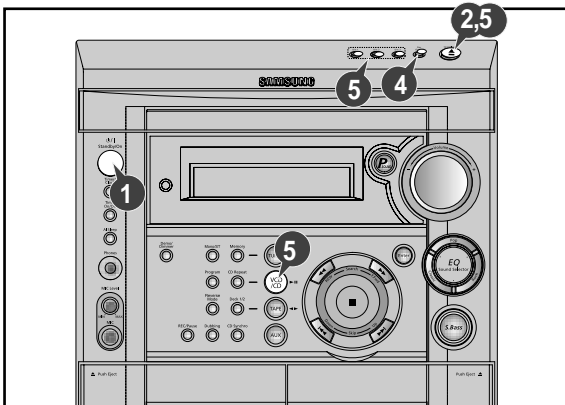

To replay the CD/MP3-CD

This is a player that enables the playback of audio CD, CD-R, CD-RW and MP3-CD and does not possess the function that saves MP3 files.

⚠ Do not use CDs of irregular shapes like heart or octagon shapes. The performance of the player may be degraded.

➤ At least more than one CD should be inserted for playbacks.

- 1 Press the **Standby/On** button to switch on the power.
- 2 Press the **VCD/CD** (▶||) of the main unit to select the CD function.
- 3 Insert more than one CD or a MP3-CD.
- 4 Press the **VCD/CD** (▶||) button of the main unit or the ▶|| button of the remote control.
➤ ♦ If there is more than one CD or an MP3-CD inserted, replays are then processed in order.
♦ Your CD Player will take a few moments to scan through all the tracks recorded on a particular MP3-CD.
♦ The English name of the song may be indicated on the display only if directly downloaded from the PC or if the purchased MP3-CD is sorted according to titles(directory). (Other languages besides English may not be indicated.)
♦ The English name of the track may not be indicated depending on the characteristics of the MP3-CD.
- 5 Adjust the volume according to needs with the following procedures.
♦ Turn the **Volume** control of the main unit.
or
♦ Press the **VOL. +** or **-** button of the remote control.
- 6 If it is desired to stop while the playback is processing, press the **VCD/CD** (▶||) button.
➤ Press the **VCD/CD** (▶||) button once again to playback again.
- 7 To stop playback, press the ■ button.

➤ ♦ A new disc may be inserted in the remaining two compartments excluding the CD which is being played back. Press the **Disc Changer** button to open the CD tray. The revolving part does not turn during playbacks.
♦ If there is not even one CD inserted in the CD tray, it is indicated as "NO DISC".
♦ If the CD Repeat function is not selected, 3 CDs are played back which automatically stops.

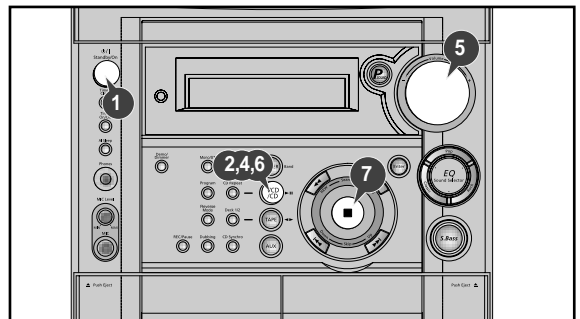

Selecting a CD in the Disc changer

GB

The CD function is automatically selected when Disc Skip is pushed.

To select a specific disc, press the corresponding **Disc (1, 2, 3)** button on the front panel or **Disc Skip** on the remote control, until the required disc indicator flashes.

Result: All the discs will be played in turn, starting with the one selected.

- If you wish to play the current disc only, press **CD Repeat** on the front panel one or more times, until **1 CD** is displayed.
- ♦ If you use the **Disc (1, 2, 3)** function when listening to the radio or to a tape, the system switches automatically to the CD mode.
- ♦ If the disc selected is not loaded, the next disc is played automatically.

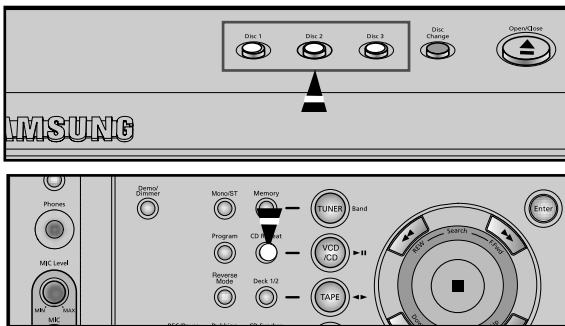

What is MP3?

MP3 means MPEG1 Layer 3, the global standard for audio signal compression technology. It uses digital compression technology to compress original sound data by up to 12 times without sound quality degradation.

File Compatibility

- ♦ The unit will playback files created in MP3 format (Mpeg1.Layer3) with *.mp3 as their extension.
- ♦ Files created in MP2 format (Mpeg1.Layer2) with *.mp2 as their extension can also be played back.

How many MP3 files can a CD-R or CD-RW disc record?

The maximum capacity of one CD-R or CD-RW disc is 680MB.

Normally, one MP3 file has a capacity of 4MB, therefore approximately 170 files can be recorded on a single disc.

Regarding the playback of CD-R/RW

- ♦ In the case of an original CD-R(Recordable) recorded in audio CD format, CD-RW(Rewritable) and editing by the user, playback is processed on the respective completed status. (The player may not be played back according to the characteristics of the CD or recorded status.)
- ♦ The CD-RW is comparably less reflexive than CD which causes more time delay to read.

MP3-CD Playback

HOW TO PLAYBACK MP3-CD directly

- 1 After inserting MP3-CD in the Set, Press the select button or Number button after Reading.
- 2 You can see the information of Disc on the TV.

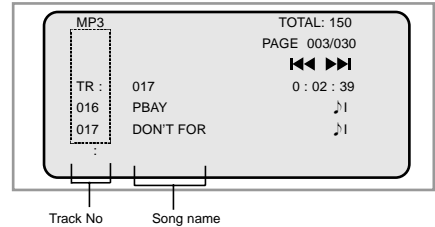

♪ 1 : MP3 File display
7 tracks on the PAL TV screen every time;
5 tracks on the NTSC TV screen every time.

Select the No of song on the remote control **Digits** button and you can enjoy the Music.

HOW TO PLAYBACK MP3-CD on MENU MODE

- 1 After inserting MP3-CD in the Set, Press the "DISC VIEW" button.
- 2 You can see the following information of Disc on the TV.

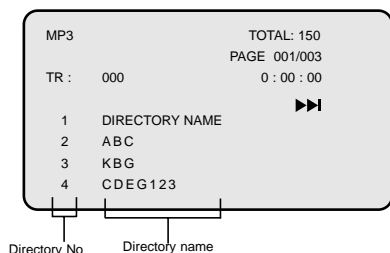

Select the Number of Directory.
You can see the following Display.

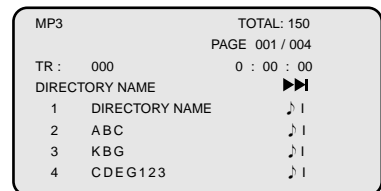

Select the No of song on the remote control **Digits** button and you can enjoy the Music.

Selecting a Track

You can select the track you wish to listen to, either when the compact disc player is stopped or when a disc is playing.

To start playback at the beginning of the... Press the **⏮** and **⏭** ...

Next track	Press ⏭ once
Current track	Press ⏮ once
Previous track	Press ⏮ twice
Track of your choice	The appropriate number of pressing the ⏮ and ⏭

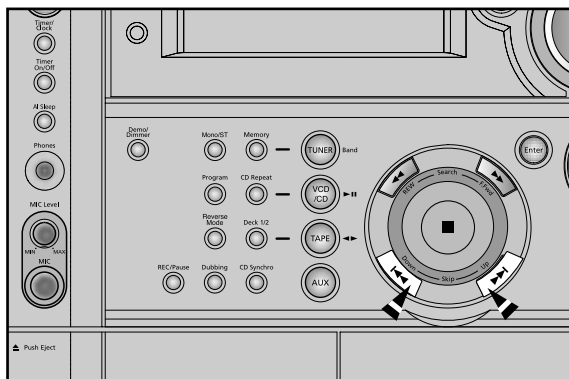

Searching for a Specific Music Passage on a CD

When listening to a compact disc, you can quickly search for a specific music passage on a track.

➤ It is recommended that you turn the volume down before using this function.

To search through the tracks... Press and hold down...

Forwards	⏭ for at least one second
Backwards	⏮ for at least one second

You can also press and hold down **⏮** / **⏭** on the front panel to auto search through the tracks.

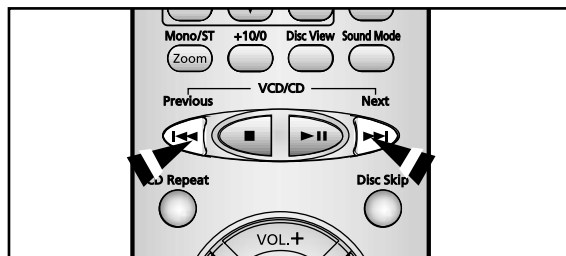

Function to skip through 10 tracks at a time

Press the **+10/0** button briefly while playing back a CD and VCD. The track 10 tracks after the current one will then be played back.

Example: If you want to select track 43 during playback of track 15, press the **+10/0** button four times, and then press the **⏭** button three times or **Digit 3** button once.

15 → 10 → 20 → 30 → 40 → 41 → 42 → 43

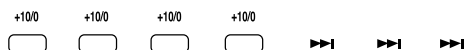

➤ In selecting a track on MP3-CD, digit "0" will be entered if the button of **+10/0** is pressed.

Example: If you want to select a track 40 during the playback of a certain track, press both buttons of 4 and **+10/0**.

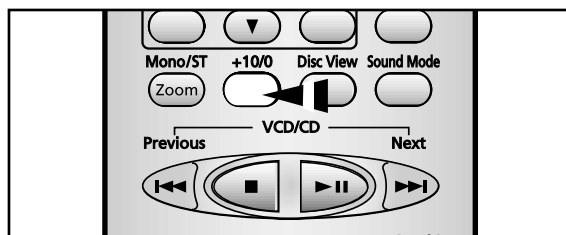

Shuffle Play Function

You can listen to the tracks on a compact disc in a different order each time, as the various tracks will be selected automatically in a random sequence.

- 1 Press the **Shuffle** button.
Result: The SHUFFLE(VCD/CD) or RANDOM(MP3-CD) indication appears and all the tracks are played in a random order. Both the track number and the playing time are displayed.
 - ◆ If this button is pressed when the CD is being played back or stopped, any track recorded in the CD may be selected to playback again.
 - ◆ The CD plays back without repetitions and in the case of the MP3-CD, a track once played back may also be played back again repeatedly.

- 2 When playing tracks in a random order, you can:
 - ◆ Move on to the next track (selected at random) by pressing **⏪/⏩**
 - ◆ Search quickly for a specific point in the current track by pressing **⏪/⏩**

- 3 When you have finished the random playback, press **■** or press the **Shuffle** button again.

➤ The Repeat and CD Synchro function is not supported from the Shuffle playback mode.

◆ **Playback of video CD Version 2.0**

- When pressing the **Shuffle** button during the playback, the operation will stop.
- When pressing the **Shuffle** button during the stop, the playback will operate with reading the video CD Version 2.0 as a Version 1.1.

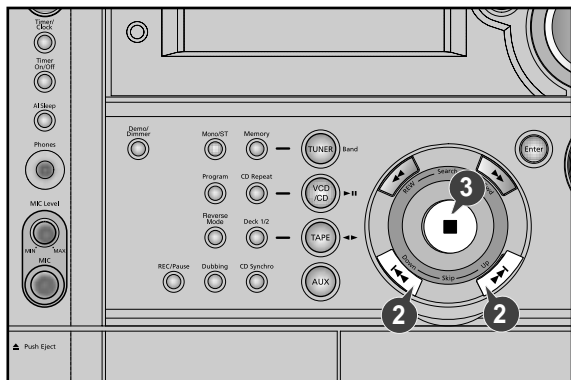

Repeating One or All Tracks on the Compact Discs

You can repeat indefinitely:

- ◆ A specific track on a compact disc.
- ◆ All tracks on the compact disc selected.
- ◆ All discs loaded in the carrousel

1 To repeat... Press CD Repeat on the Front Panel one or more times until...

The current track indefinitely **REPEAT 1** is displayed
 The selected disc **REPEAT 1 CD** is displayed
 All discs loaded **REPEAT ALL CD** is displayed

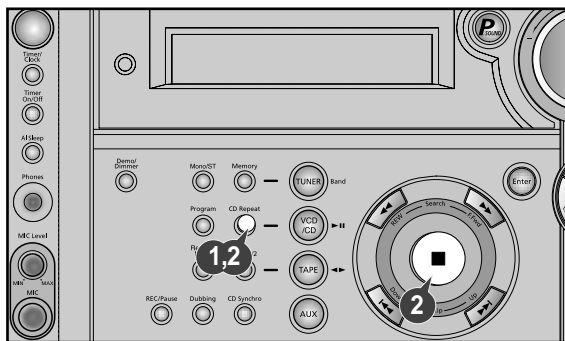

- 2 When you wish to stop the Repeat function, press **CD Repeat** until **ALL CD** or **1 CD** is displayed, or press **■**.



Programming the Order of Playback

You can decide:

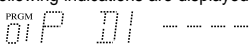
- ◆ The order in which you listen to the tracks on the discs loaded
- ◆ Which tracks you do not wish to listen to
- ◆ A maximum of up to 30 order of tracks desired to listen may be programmed.
- ◆ Before selecting the track, the VCD player should be stopped.
- ◆ This function may be used simultaneously with the CD Repeat function.

- 1 If the CD function is selected, stop the player by pressing ■ .
- 2 Load the selected CDs.
- 3 Press **Program**.
Result: The following indications are displayed:

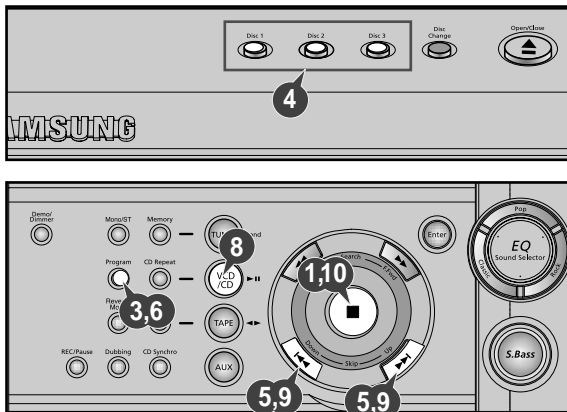
(01 = Programme No, DI = Disc No, -- = Track No on the disc)
- 4 If necessary, select the disc containing the required track by pressing the corresponding **Disc (1, 2, 3)** button.
- 5 Select the required track by pressing the ◀◀ and ▶▶ button:
◆ Press ◀◀ to move back through the tracks
◆ Press ▶▶ to move forward through the tracks
- 6 Press **Program** to confirm your selection.
Result: The selection is stored and  is displayed.
- 7 To select other tracks, repeat Steps 4 to 6.
- 8 Press **VCD/CD (▶▶)** to listen to the track selection in the order programmed.
- 9 **To...** **Press the ◀◀ and ▶▶...**
Listen to the current track again..... Press ◀◀ once
Listen to the previous track..... Press ◀◀ twice
Listen to the next track..... Press ▶▶ once
Skip forwards or backwards one..... The appropriate number of
or more tracks pressing the ◀◀ and ▶▶
- 10 To cancel the selection, press ■ .
◆ Once if the compact disc player is stopped
Result: PRGM is no longer displayed.
➤ ◆ If you open the compartment, the selection is cancelled.
◆ If you select the number of a disc which is not loaded or a track which does not exist on the CD, the selection skips to the next programmed track.

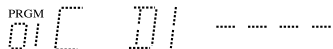

Checking or Changing Programmed Tracks

You can check or change your selection of tracks at any time.

- 1 Press ■ once if you have started listening to the selection.
- 2 Press **Program**.
Result: The following indications are displayed:

(C = Check, 01=Program No, DI = Disc No, --- = Track No on the disc)
➤ If you have already programmed 30 tracks, C is displayed instead of P when you press **Program**.
- 3 Press **Program** again.
Result: The first track selected is displayed, together with the letter C (Change).
- 4 Press **Program** one or more times until the track to be changed is displayed.
- 5 If necessary, press the corresponding **Disc (1, 2, 3)** button to change discs.
- 6 Press ◀◀ and ▶▶ to select a different track.
- 7 Press **Program** to confirm your change.
- 8 Press **VCD/CD (▶▶)** to start listening to the selection.
Result: The first track selected is played.

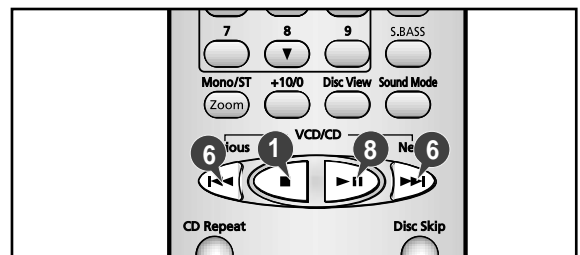
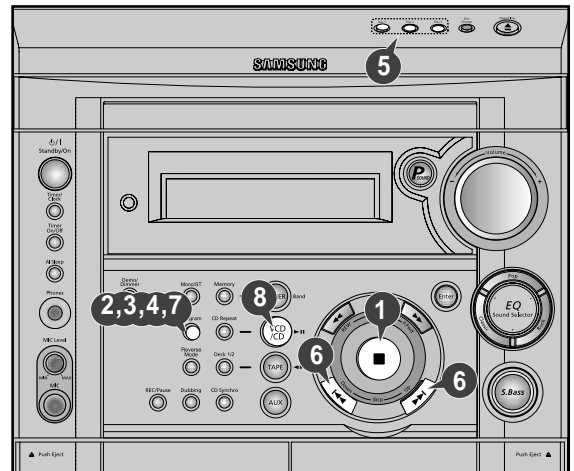
- When selecting the tracks of numbers larger than 3 digit figures (figures from the number 100), please use the **Digit** buttons.



Video CD Player Playback

GB

In order to playback video VIDEO-CD(S), make sure that your unit is connected to your TV set.

This unit is designed for playback of video CD(S), version 1.1 and 2.0. Only with version 2.0, is it possible to call up the on screen menu function. This unit will not play back any other video VIDEO-CD(S) other than 1.1 and 2.0 versions.

- 1 Turn on the **Standby/On** switch and set the VCD mode.
- 2 Press the **Open/Close** (▲) button on the unit, to open the CD tray.
Result: "OPEN" is displayed and CD tray slides open.
- 3 Load a video-CD(S) with the label facing upwards in the tray.
- 4 Press the **Open/Close** (▲) button again to close the CD tray.
- 5 To playback:
 - ◆ In version 1.1, press the ►► button for direct access to the film, as there is no menu-on-screen.
 - ◆ In version 2.0, load a video CD, "Video CD2.0", and "MENU ON" are displayed on the TV screen. Press the ►► button and the menu is displayed on the TV screen. Select a number from the menu using **Digits** button on the remote control and press the **VCD/CD** (►►) button.
- To return to the previous menu, press the **Return** button on the remote control or the **Enter** button on the front panel .
- ◆ When playing a video-CD(S) version 2.0, reading time on the display may take longer, depending on the disc's contents.
- 6 Press ►► button on the remote control to receive a still picture.
Result: Pause is displayed, a still picture appears and the sound is muted.
- 7 To return to normal playback, press **VCD/CD** (►►) button.
- 8 Press the Stop (■) button to stop playback.

- ◆ Please make sure that the VIDEO-CD(S) to be played is not flawed optically, as this may cause a distorted sound or the unit to malfunction.

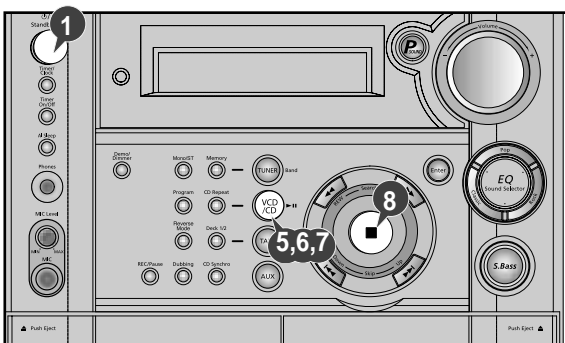
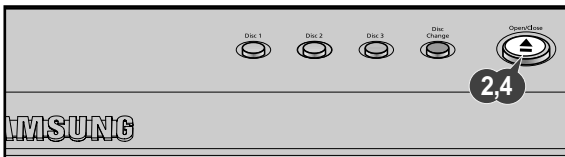

Search Functions

You can find a certain passage faster during playback. This function is possible in CD or VCD Ver 1.1 or Ver 2.0 menu off mode.

- | 1 | To... | Press and hold down... |
|---|----------------------|------------------------|
| | Scan forwards | ►► |
| | Scan backwards | ◄◄ |
- 2 Release the **Skip/Search** buttons when the desired passage has been found.

- In the video CD version 1.1, where the disc's contents are over 15 minutes long, you can scan up or down by intervals of five minutes.

- | 3 | To... | Press... |
|---|--|----------|
| | Scan forwards by 5 minute intervals..... | ►► |
| | Scan backwards by 5 minute intervals | ◄◄ |
- Result: The picture is still, and the disc's contents are forwarded or reversed by 5 minute intervals. Playback then resumes from this new position.

- In the SKIP/SEARCH or SCAN mode, the sound can only be partially heard and the picture scenes will change sporadically, until the required passage has been found.

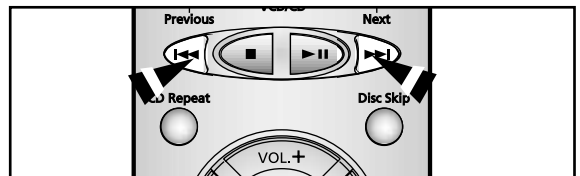

Time Search Function

(This function is available only during the playback of a CD/VCD)

Please use this function for reproducing a desired track in a certain time of playback.

- 1 Press the **Time Search** button.
- 2 Set a desired time by pressing the **Digit** buttons.
- 3 Press the **Play** (►►) button.

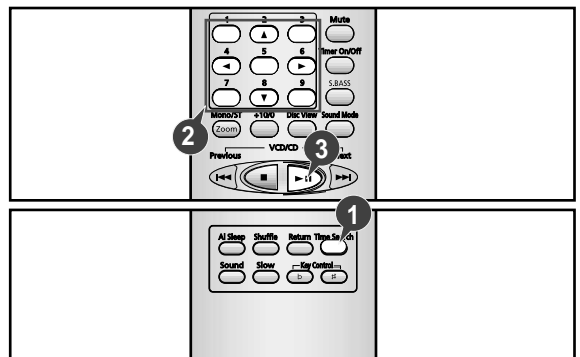

When adjusting play speed

Turn on the TV and set video mode.

- Press the **Slow** button on the remote controller when the play function is on.
- ◆ Voices do not come out when the **Slow** button is pressed.
 - ◆ Slow playing is 1/2, 1/4, 1/8 the normal playing speed.

To return to normal operation.

- ◆ Press the **VCD/CD** (▶||) button.

➤ When the slow mode or frame mode is selected a disc will only forward operation.

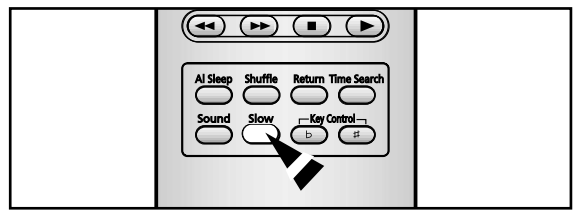
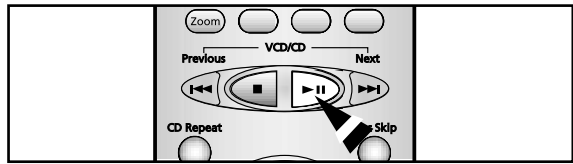
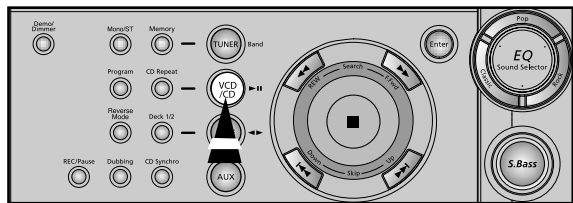

NTSC/PAL Selection Method

According to a DISC or TV, Press the **REC/Pause** button on the front panel.

Set the system to standby(power off) mode, press the **REC/Pause** button on the front panel.

Result: Each time the **REC/Pause** button is pressed, the following appears in the display:

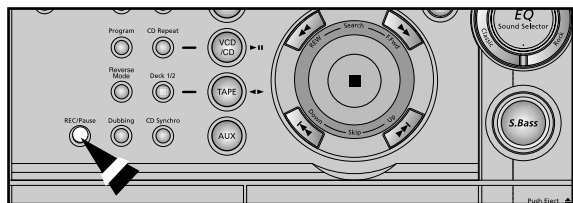
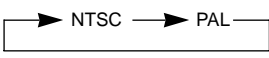

Sound Select Function

With this function, you can playback video CD's that provide 2-channel tone(bilingual) in the original language. Similarly, with karaoke video CD's, you can select between the channel for music without vocals for sing-along purpose, or the channel complete with music and vocals.

During playback, press the **Sound** button on the remote control.

Result: Each time the **Sound** button is pressed, the following appears in the display and on the TV screen:

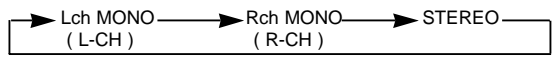

- ◆ **Lch MONO** : Only the left channel (instrumental parts) is played back through both the right and left speakers.
- ◆ **Rch MONO** : Only the right channel (vocal parts) is played back through both the right and left speakers.
- ◆ **STEREO** : Cancels the Multiplex Sound (normal stereo playback resumes).

➤ You can select between listening to the tone from the left channel, the right channel or both channels.

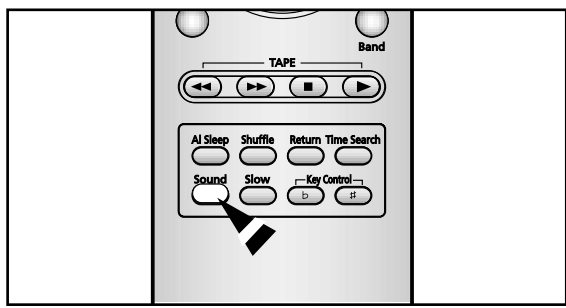

KEY CONTROL Function

This function can work only at VCD mode when microphone is connected.

Press the **Key Control** button to adjust the key to your voice. (the 15 step key control you can select)

Result: Each time the **Key Control #, b** button is pressed, the following appears on the TV screen: "KEY #-"

- b** : Low-Pitched Key
- #** : High-Pitched Key

➤ Key control function and VCD slow playing function do not work at the same time .

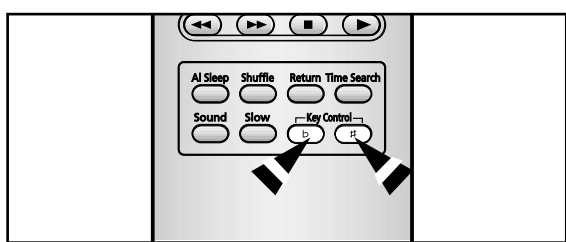

VCD VIEW function

This function can be used conveniently to search a desired track in a VCD. This function is possible in VCD Ver 1.1 and Ver 2.0 menu off mode.

When you want to select a track

- 1 Press the **Disc View** button in the stop state.
Result: "TRACK VIEW" menu is displayed on the screen.
The screen is split into 9 with each screen picture being reproduced for 4 seconds.
 - Press NEXT (▶▶) button to see the rest tracks.
 - Press PREV.(◀◀) button to see the previous tracks.
- 2 Select a track by pressing the **Digits** buttons.
- 3 Press the **VCD/CD** (▶||) button.
Result: The picture that you selected is displayed in full screen.
- 4 When you wish to stop the DISC VIEW function, press the **■** button.
 - ◆ **When using more than 10 tracks :**
Press the **Digits** and **+10/0** button, select the desired track number(Reference page 13).
 - Press NEXT (▶▶) button to see the next track.
 - Press PREV.(◀◀) button to see the previous track.

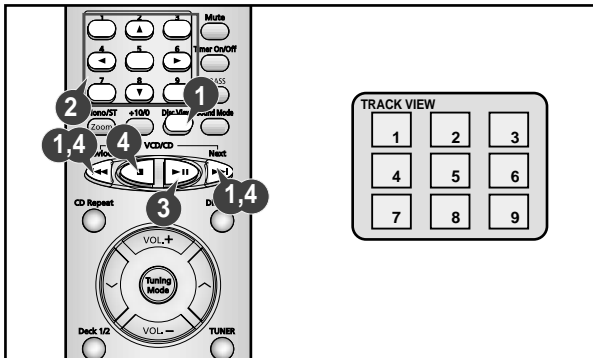

When you want to select an INDEX

This function is convenient to search a desired scene as it displays a track reproduced by time.

- 1 Reproduce the pictures by pressing (▶||) button.
- 2 Press the **Disc View** button.
Result: "INDEX VIEW" menu is displayed on the screen.
The screen is split into 9 with each screen picture being reproduced for 4 seconds.
- 3 Reproduce the pictures by pressing a desired **Digits** button.
Result: The one of nine picture is displayed in full screen.

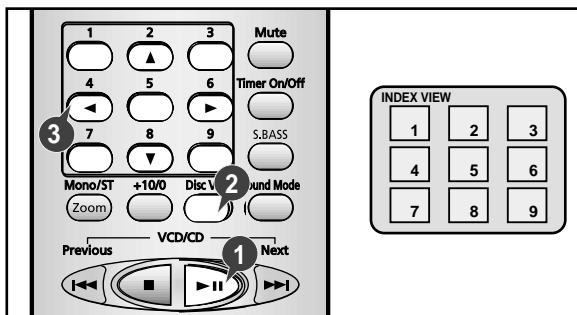

ZOOM Function

- 1 Press **Zoom** button during playback.
Result: The picture being reproduced will be enlarged twice as large as the previous one.
- 2 Press **Zoom** button once more in the state of double sized zoom.
Result: The picture being reproduced is enlarged four times as large as the initial one.
- 3 Press **Zoom** button in the state of four times sized zoom.
Result: The picture will return to the initial size.
 - ◆ During operating the zoom function, if you want to move the picture upward/downward/leftward/rightward, please press the respective **Digits** button (2,4,6,8).

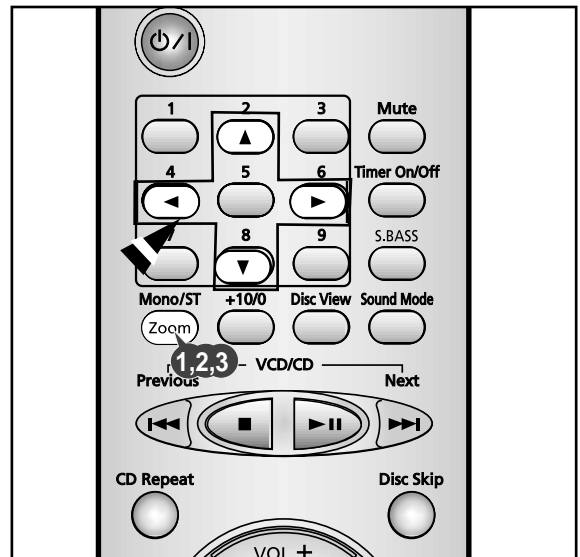

Last Memory Function

When CD playback is selected again after your CD player has been stopped or turned off, this function allows playback from the start of the track that you last listened to.

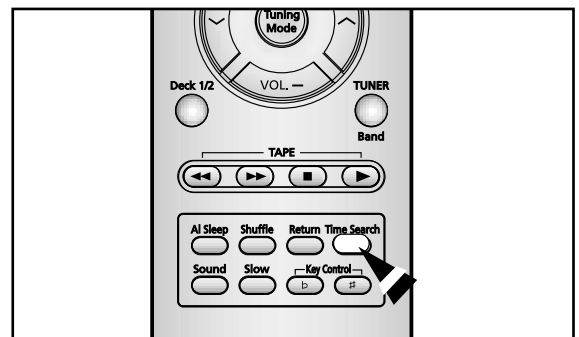

Searching for and Storing the Radio Stations

You can store up to:

- ◆ 15 FM stations or ◆ 15 FM stations
- ◆ 5 MW stations ◆ 15 AM stations(or 8MW,7LW Station)
- ◆ 5 SW1 stations
- ◆ 5 SW2 stations

- 1 Switch the system on by pressing **Standby/on**.
- 2 Select the **TUNER** function by pressing **TUNER**.
- 3 Select the required frequency band by pressing **TUNER (Band)** again on the front panel or **TUNER (Band)** on the remote control.
Result: The appropriate indication is displayed:
 - ◆ **FM** Frequency Modulation
 - ◆ **AM(MW)** Medium Wave
 - ◆ **LW(Optional)** Long Wave
 - ◆ **SW1(Optional)** Short Wave
 - ◆ **SW2(Optional)** Short Wave

- 4 Tune in to the desired station.

Manual tuning

- ◆ Press the **Tuning Mode** button so that the "MANUAL" indicator lights up on the front panel display.
- ◆ Press **◀ / ▶** on the main unit to tune in to the desired station manually.
or
- ◆ Press **Tuning** **∨** or **∧** on the remote control to do the same.

Automatic tuning

- ◆ Press and hold **◀ / ▶** on the main unit for more than 1 second so that the "AUTO" indicator lights up on the front panel display.
 - ◆ Press and briefly hold **◀ / ▶** on the main unit to begin automatic tuning.
or
 - ◆ Press and briefly hold **Tuning** **∨** or **∧** on the remote control to do the same.
- ◆ Use the manual tuning method if the automatic tuning search does not stop at the desired station because the signal is weak.

For details on the Preset function, see the "Selecting a Stored Station" on page 19.

- 5 Adjust the volume by:
 - ◆ Turning the **Volume** knob on the front panel
 - or
 - ◆ Pressing the **VOL. +** or **-** buttons on the remote control
- 6 Select the FM stereo or mono mode by pressing **Mono/ST.**
- 7 If you do not want to store the radio station found, revert to Step 4 and search for another station.
Otherwise:
 - a Press **Memory**.
Result: The **PRGM** is displayed for a few seconds.
 - b Press **Tuning Down** and **Up** to assign a programme number between 1 and 15.
 - c Press **Memory** to store the radio station.
Result: **PRGM** is no longer displayed and the station is stored.
- 8 To store any other radio frequencies required, repeat Steps 3 to 7.

- The PROGRAM function can be used to assign a new station to an existing programme number.

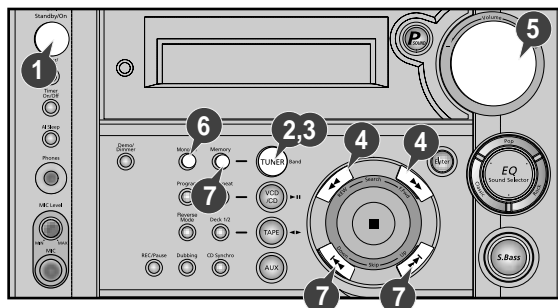
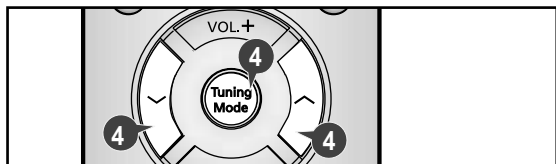

Selecting a Stored Station

You can listen to a stored radio station as follows:

- 1 Switch the system on by pressing **Standby/on**.
- 2 Select the **TUNER** function by pressing **TUNER**.
- 3 Select the required frequency band by pressing **TUNER (Band)** on the remote control or **TUNER (Band)** again on the front panel.
- 4 Press **◀ / ▶** button on the front panel of the unit, or the **Tuning Mode** button on the remote control until "PRESET" is displayed.
- 5 Press **◀ / ▶** to select the desired station.
or
Select the desired station by pressing the station number stored, using the **Tuning** **∨** or **∧** button on the remote control.
Result: The desired station is now received.

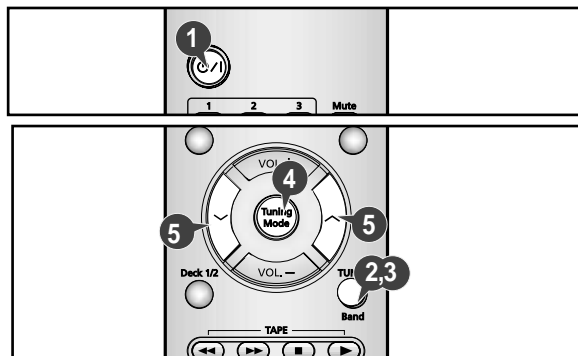

Improving Radio Reception

You can improve the quality of radio reception by:

- ◆ Rotating the FM or AM(MW) aerial
 - ◆ Testing the positions of the FM and AM(MW) aerials before fixing them permanently
- If reception from a specific FM radio station is poor, press **Mono/ST.** on the remote control to switch from stereo mode to mono.
The quality of the sound will be improved.

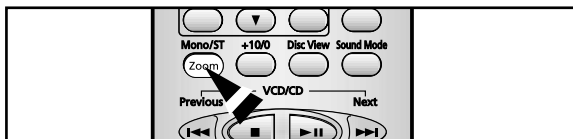

Listening to a Cassette



- Always treat your cassettes with care: refer, if necessary, to the section entitled "Precautions When Using Audio Cassettes" on page 26.

- 1 Switch the system on by pressing the **Standby/On** button.
- 2 Select the TAPE function by pressing **TAPE**.
- 3 Open either cassette deck 1 or 2 by pushing and releasing the deck cover where **Push Eject** (▲) is written.
- 4 Insert the pre-recorded cassette with the open edge of the tape facing downward.
- 5 Close the deck by pushing on it until it clicks into place.
Result: Depending on the deck selected, the 1 or 2 indication is displayed in front of the counter number.

- If you insert a cassette in both decks, the system selects the deck in which you inserted the second cassette.

- 6 If you have inserted two cassettes, press **Deck 1/2** on the front panel or directly the **Deck 1/2** button on the remote control to select the cassette to be played.
Result: Depending on the deck selected, the TAPE 1 or TAPE 2 indication is displayed.

To listen to...	Press ...
Side A	TAPE (◀▶) once DECK 1 and DECK 2
Side B	TAPE (◀▶) twice DECK 2 Only

Result: The cassette starts playing.

When the cassette is stopped, select one of the following functions as required.

To...	Press ...
Rewind the cassette	◀◀
Fast-forward the cassette	▶▶

When you have finished the function, press **TAPE ■** on the remote control or **■** on the front panel to stop.

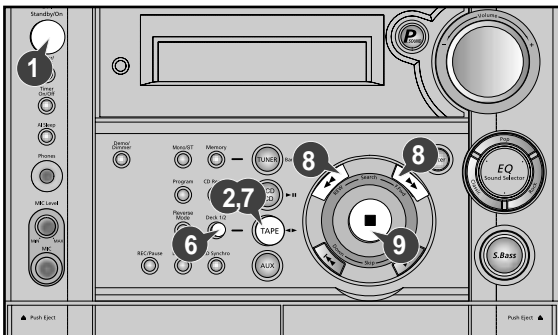

CD Synchro Record Feature

You can record a compact disc on a cassette in two different ways:

- ◆ Synchronised recording
- ◆ Direct recording

This feature enables you to synchronize the start of the recording with the start of the disc or track of your choice.

- 1 Switch the system on by pressing **Standby/On**.
 - 2 Insert a blank cassette in Deck 2.
 - 3 Select the CD function by pressing **VCD/CD** on the front panel.
 - 4 Load a compact disc.
 - 5 Select the required disc.
 - 6 Select the required track and press **CD Synchro** or press **CD Synchro** directly to start recording at the beginning of the disc.
Result: "REC" and "CD-SYNC" are displayed and recording starts.
- | To stop... | Press ... |
|--|-----------|
| Recording and playing the compact disc | ■ |

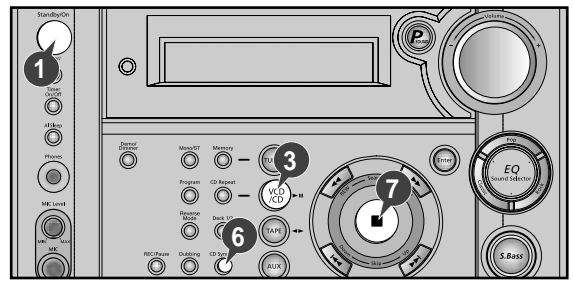

Recording a Compact Disc

The direct recording mode enables you to start recording with any track on the compact disc.

- ◆ You can only record on cassettes in Deck 2.
- ◆ You do not need to adjust the volume, as it has no effect on the recording.

- 1 Switch your system on by pressing **Standby/On**.
- 2 Insert a blank cassette in Deck 2.
- 3 Select the CD function by pressing **VCD/CD** on the front panel.
- 4 Load the compact disc.
- 5 Select the required disc.
- 6 Select the required track on the compact disc and press ▶|| on the front panel or ▶|| on the remote control to set the compact disc player to Pause mode.
- 7 Press the **REC/Pause**.
Result: REC is displayed .
- 8 Press the ▶|| to start playing the track.
Result: The track is recorded on the cassette.
- 9 When you have finished recording, press **TAPE ■** on the remote control or **■** on the front panel to stop recording.

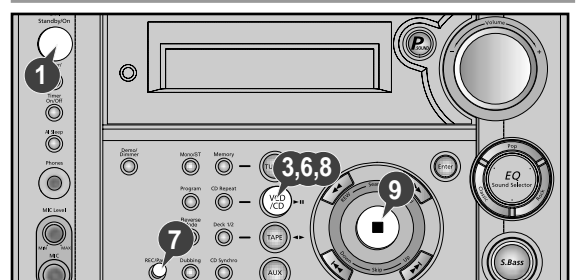

Recording a Radio Programme

You can record a radio programme of your choice.

- ◆ You can only record on cassettes in Deck 2.
- ◆ You do not need to adjust the volume, as it has no effect on the recording.

- 1 Switch the system on by pressing **Standby/On**.
- 2 Insert a blank cassette in Deck 2.
- 3 Select the **TUNER** function by pressing **TUNER**.
- 4 Select the radio station that you wish to record by pressing **Tuning Up** or **Tuning Down** on the remote control or by press the **Tuning Down** or **Up** on the front panel.
- 5 Press **REC/Pause**.
Result: **REC** is displayed in red and recording starts.
- 6 When you have finished recording, press the **TAPE** on the remote control or **TAPE** on the front panel to stop recording.

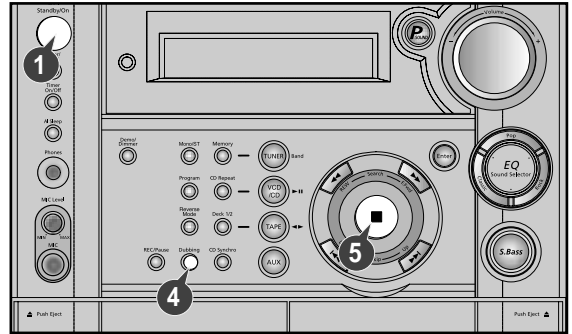

Selecting the Cassette Playback Mode (Deck 2 Only)

Your mini-compact system has three cassette playback modes which enable you to listen to both sides of a cassette automatically. Press **REV.** Mode until the appropriate symbol is displayed.

When the display indicates... The mini-compact system plays back...

- One side of the selected cassette and then stops.
- One side of the cassette. The other side of the cassette and then stops.
- Both sides of the cassette indefinitely until you press stop.

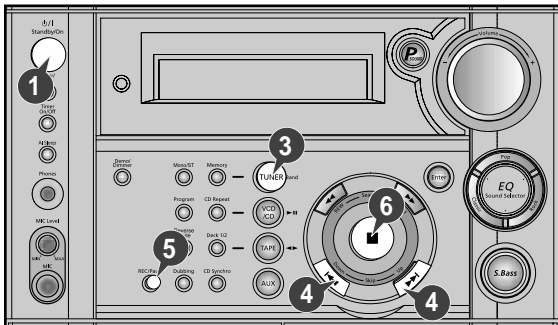

Copying a Cassette (Dubbing)

You can copy a cassette from Deck 1 to Deck 2. Two options are available:

- ◆ You do not need to adjust the volume, as it has no effect on the recording.
- ◆ Take care not to insert the tape to be copied in Deck 2, as it will be erased when you start recording.

- 1 Switch your system on by pressing **Standby/On**.
- 2 Insert a blank cassette in Deck 2.
- 3 Insert the tape to be copied in Deck 1.
- 4 **To copy a cassette at... Press...**
Normal speed dubbing Dubbing

Result: The appropriate indications are displayed and the cassette in Deck 1 is copied to the cassette in Deck 2.

- 5 Press **TAPE** on the front panel or **TAPE** on the remote control when you have finished recording.

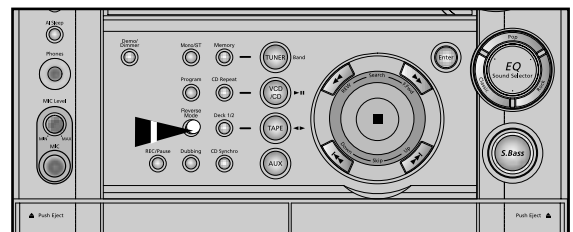

Timer Function



The timer enables you to switch the system on or off at specific times.

Example: You wish to wake up to music every morning.

➤ If you no longer want the system to be switched on or off automatically, you must cancel the timer.

- ◆ Before setting the timer, check that the current time is correct.
- ◆ For each step, you have a few seconds to set the required options. If you exceed this time, you must start again.

- 1 Switch the system on by pressing **Standby/On**.
 - 2 Press **Timer/Clock** until \odot **TIMER** is displayed.
 - 3 Press **Enter**.
Result: **ON TIME** is displayed (instead of the equalizer symbols) for a few seconds, followed by any switch-on time already set; you can set the timer switch-on time.
 - 4 Set the timer switch-on time.
 - a Set the hour by pressing the \lll / \ggg buttons.
 - b Press **Enter**.
Result: The minutes flash.
 - c Set the minutes by pressing the \lll / \ggg buttons.
 - d Press **Enter**.
Result: **OFF TIME** is displayed (instead of the equalizer symbols) for a few seconds, followed by any switch-off time already set; you can now set the timer switch-off time.
 - 5 Set the timer switch-off time.
 - a Set the hour by pressing the \lll / \ggg buttons.
 - b Press **Enter**.
Result: The minutes flash.
 - c Set the minutes by pressing the \lll / \ggg buttons.
 - d Press **Enter**.
Result: **VOL XX** is displayed, where **XX** corresponds to the volume already set.
 - 6 Press **Tuning Down and Up** to adjust the volume level and press **Enter**.
Result: The source to be selected is displayed.
 - 7 pressing the \lll / \ggg buttons to select the source to be played when the system switches on .
- | If you select... | You must also... |
|-----------------------------|---|
| TAPE (cassette)..... | Insert a recorded cassette in one of the decks before setting the system to standby. |
| TUNER (radio)..... | <ol style="list-style-type: none"> a Press Enter. b Select a preset station by pressing the \lll / \ggg buttons. |
| VCD/CD (compact disc) | <ol style="list-style-type: none"> a Load one or more compact discs. b Select the required disc. |
- 8 Press **Enter** to confirm the timer.
 - 9 Press **Standby/On** to set the system to standby mode.
Result: \odot is displayed to the bottom left of the time, indicating that the timer has been set. The system will switch on and off automatically at the required times.

➤ If the timer switch on and off times are identical, the word **ERROR** is displayed.

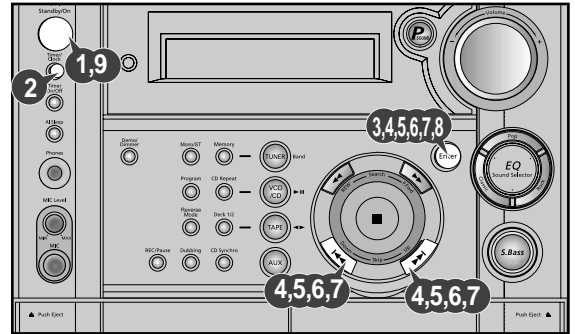

Cancelling the Timer

After having set the timer, it will start automatically as shown by the **TIMER** indication on the display. If you no longer wish to use the timer, you must cancel it.

➤ You can stop the timer at any time (system on or in standby mode).

To...	Press Timer On/Off...
Cancel the timer	Once. Result: \odot is no longer displayed.
Restart the timer	Twice. Result: \odot is displayed again.

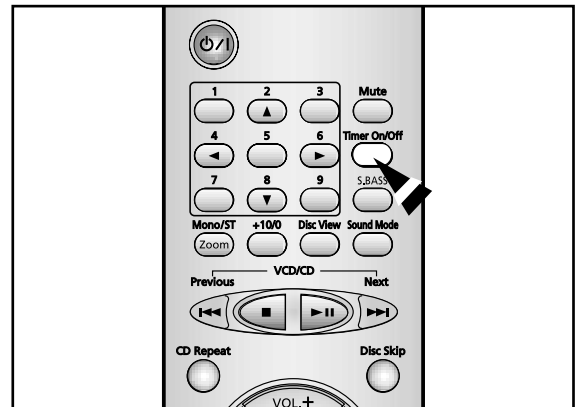

Mute Function

You can turn the sound off temporarily on your system.
Example: You wish to answer a telephone call.

- 1 Press **Mute**.
- 2 To switch the sound back on (at the same volume as before), press **Mute** again or the **Volume** buttons.

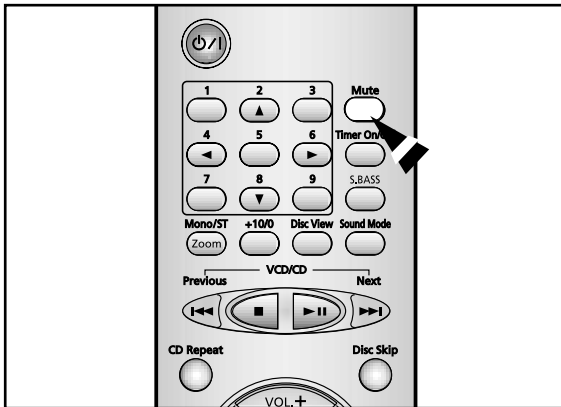

Selecting an Equalizer Preset

Your mini-compact system is equipped with a preset equalizer that allows you to choose the most appropriate balance between treble and bass frequencies, according to the type of music you are listening to.

Press **EQ** on the front panel until the required option is selected.

To obtain a...	Select...
Normal balance (linear)	PASS
Balance suitable for pop music	POP
Balance suitable for rock music	ROCK
Balance suitable for classic music	CLASSIC

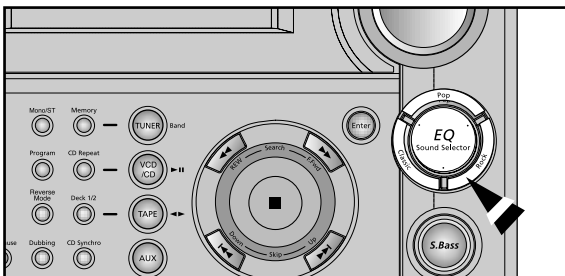

How to adjust USER EQ?(option)

You can freely set the desired tone (BASE/TREBLE) by using the USER EQ function.

- 1 Press the **Sound Mode** button longer.
Result: "USER EQ" flashes on the display for 5 seconds.
- 2 Press the **Tuning Mode** button.
Result: TREBLE level appears on the display.
 (Factory-set TREBLE level is "HIGH 0 dB".)
- 3 Press **Tuning** \downarrow , \uparrow to adjust the TREBLE level (-6 to +6).
 * TREBLE level can be adjusted at a 2 dB increment.
- 4 Press the **Tuning Mode** button to complete the setting.
 \blacktriangleright This function is available only on the remote control.

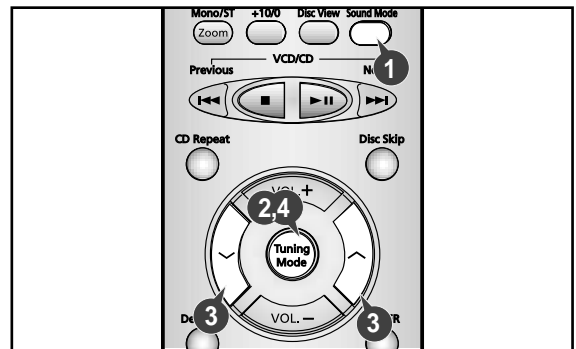

Power Sound Function

Your mini-compact system is equipped with the function of Power Sound .
 The function of Power Sound amplifies bass and improves high key or bass twice as much for you to appreciate powerful real sound.

\blacktriangleright To select **P.SOUND**

- ◆ Press **P.SOUND** button on the front panel, "P.SOUND" is displayed.
- ◆ To cancel this function, press **P.SOUND** button again and "OFF" is displayed for a few seconds.

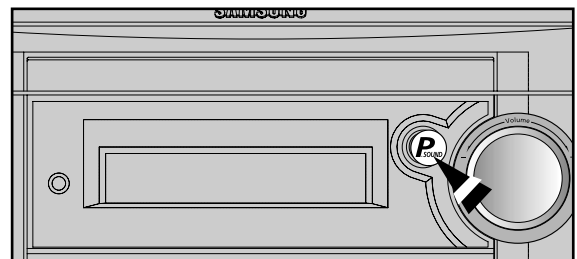

Setting the System to Switch off Automatically

GB

While listening to a compact disc or a cassette, you can set the system to switch off automatically

Example: You wish to go to sleep to music.

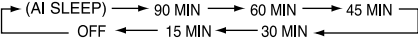
- 1 Press **AI Sleep**.
Result: playback starts and the following indications are displayed:
90 MIN
- 2 Press **AI Sleep** one or more times to indicate how long the system should continue playing before it switches off:

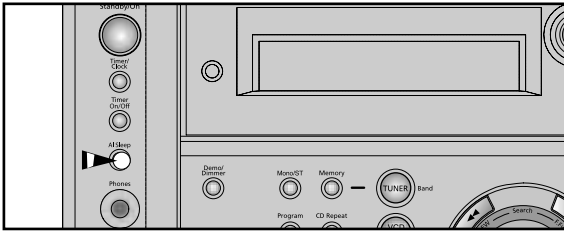
 - At any time, you can:
 - ◆ Check the remaining time by pressing **AI Sleep**
 - ◆ Change the remaining time by repeating Steps 1 and 2
- 3 Press **AI Sleep** one or more times until **AI SLEEP** is displayed.
Result: The system will automatically switch off at the end of disc or cassette.
- 4 To cancel **SLEEP** function, press **AI Sleep** one or more times until **OFF** is displayed.



Super Bass Sound

Your mini-compact system has a bass amplification function called S.Bass (Super Bass Sound). This function makes the sound more powerful and real.

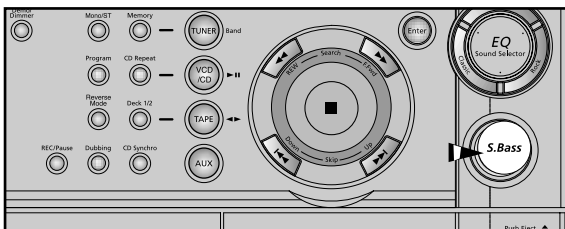
- 1 Press the **S.Bass** button on the front panel.
Result: **S. BASS** is displayed and "SBS ON" is displayed for a few seconds.
- 2 To cancel this function, press **S.Bass** button again.



Connecting Headphones

You can connect a set of headphones to your mini-compact system so that you can listen to music or radio programmes without disturbing other people in the room. The earphones must have a 3.5 mm jack or an appropriate adapter.

Connect the headphones to the **Phones** jack on the front panel.
Result: The loudspeakers are no longer used to output the sound.

➤ Prolonged use of headphones at a high volume may damage your hearing.

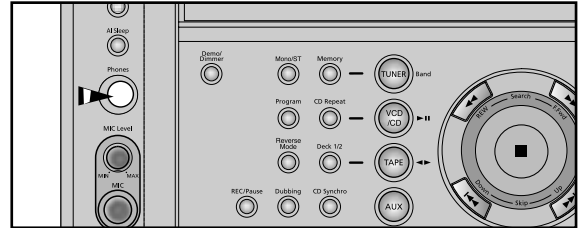

Microphone Function

The microphone enables the user to mix in his or her vocals to sing-along with the music.

Preparation

Plug the microphone with a 6.3mm mic jack into microphone terminal.

- 1 Turn the **MIC Level** knob to adjust the mic volume.

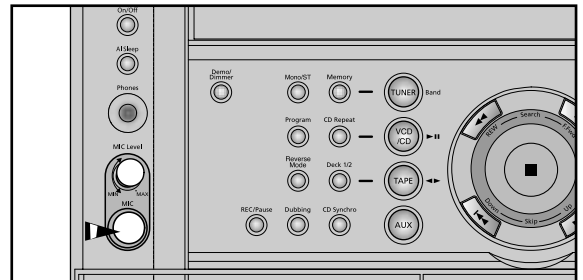

Safety Precautions

The following diagrams illustrate the precautions to be taken when using or moving your mini-compact system.

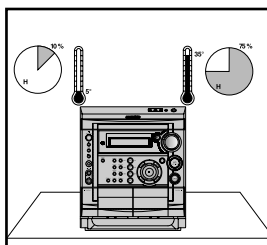

Ambient operating conditions:
Ambient temperature 5°C-35°C
Humidity 10-75%

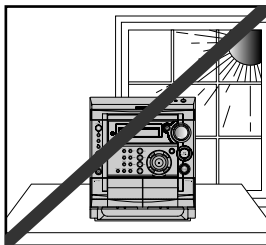

Do not expose the unit to direct sun radiation or other heat sources. This could lead to overheating and malfunction of the unit.

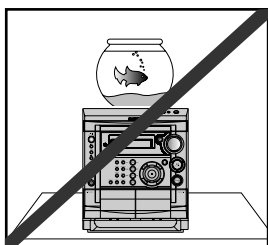

Do not place potted plants or vases on top of the unit. Moisture entering the unit could lead to dangerous electric shock and can cause equipment damage. In such events immediately disconnect the main plug from the socket.

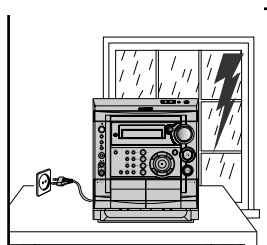

During thunderstorms, disconnect the main plug from the socket. Main voltage peaks due to lightning could damage the unit.

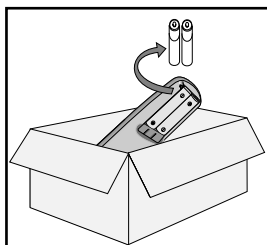

Remove the batteries from the remote control, if not used for any extended period. Leaking batteries can cause serious damage to the remote control.

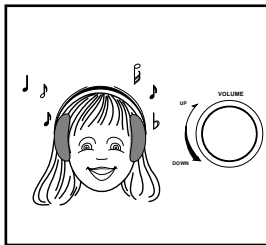

When using headphones, take care not to listen at excessive volumes. Extended use of headphones at high volumes will lead to hearing damage.

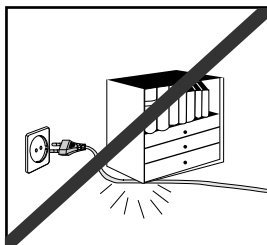

Do not place heavy items on the main lead. Main cable damage can lead to damage of the equipment (fire hazard) and can cause electric shock.

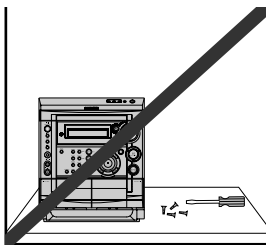

Do not remove any equipment panels. The inside of the unit contains live components, which cause electric shock.

Cleaning Your Mini-Compact System

GB

To obtain the best possible results from your mini-compact system, you must clean the following elements regularly:

- ◆ The outer casing
 - ◆ The compact disc player
 - ◆ The cassette players (heads, rollers and drive capstans)
- ☛ Always unplug the system from the wall outlet:
- ◆ Before cleaning it
 - ◆ If you are not going to be using it for a long time

Outer Casing

Clean the outer casing regularly using a soft cloth and a light detergent. Do not use abrasive powders, liquids or aerosol cleaners. Never let any liquids get into the system.

Compact Disc Player

- 1 Before playing a compact disc, clean it with a special CD cleaning agent. Do not use the same cleaning agents as for vinyl LP records. Carefully wipe the disc from the centre outward.
- 2 Regularly clean the player with a special cleaning disc (available from your local dealer).

Tape Decks

- 1 Press Push Eject (▲) to open the cassette deck.
- 2 Use a cotton bud and a special cassette cleaning agent to clean the:
 - ◆ Head (1)
 - ◆ Rollers (2)
 - ◆ Drive capstans (3)

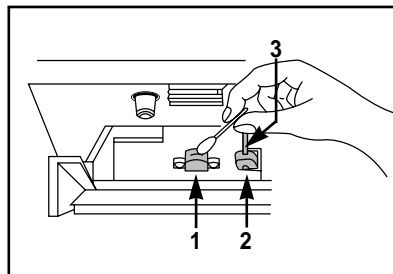

- ☛ If you will not be using the remote control for a long time, remove the batteries to prevent corrosion.
- ◆ Although your system is very hard-wearing, it should not be used in an excessively dusty environment or subjected to shocks or extreme heat (close to heating appliances or in direct sunlight, etc.).
- ◆ If the unit emits an unpleasant odor when in use, unplug it from the main supply and contact the after-sales service.

Precautions When Using Compact Discs

GB

- ◆ Handle your compact discs with care. Always hold them by the edges to avoid leaving fingerprints on the shiny surface.
- ◆ When you have finished playing a compact disc, always put it back in its case.
- ◆ Do not fix paper or adhesive tape to the discs and do not write on the label.
- ◆ Clean them with a special-purpose cloth.
- ◆ Store your compact discs in a clean place, out of direct sunlight, where they will not be exposed to high temperatures.
- ◆ Always use compact discs marked  .

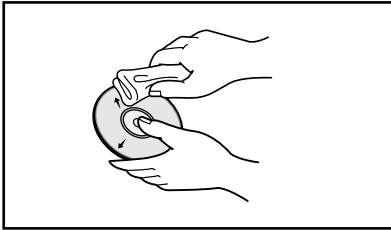

Precautions When Using Audio Cassettes

- ◆ Check that the tape in the cassette is sufficiently taut.
- ◆ To prevent erasing a cassette that you wish to keep, remove the safety tab on the upper edge of the cassette. To record a cassette, where the tab has been broken, simply cover the opening with adhesive tape.
- ◆ When you have finished playing a cassette, always put it back in its case.
- ◆ Store your cassettes in a clean place, out of direct sunlight, where they will not be exposed to high temperatures.
- ◆ Avoid using 120-minute cassettes as they place unnecessary strain on the tape mechanism.

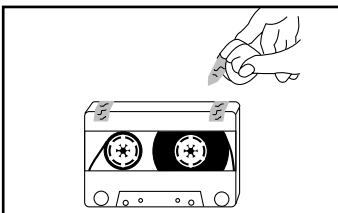
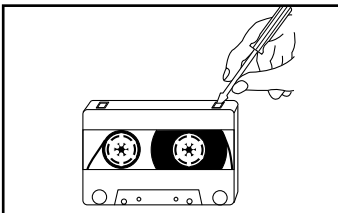
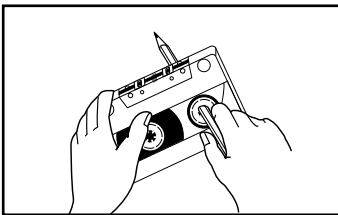

Before Contacting the After-Sales Service

It always takes a little time to become familiar with a new appliance. If you have any of the problems listed below, try the solutions given. They may save you the time and inconvenience of an unnecessary service call.

Problem	Checks/Explanation
The system does not work	<ul style="list-style-type: none"> • The main lead is not correctly plugged into a wall socket or the wall socket is not switched on. • The remote control batteries need replacing or the polarity has not been respected. • The Standby/On button has not been pressed.
There is no sound	<ul style="list-style-type: none"> • The volume has been completely turned down. • The correct function (TUNER, CD, TAPE, AUX) has not been selected. • You have connected a set of earphones. • The loudspeaker wires have been disconnected. • The Mute button has been pressed.
The Timer does not work	<ul style="list-style-type: none"> • The timer has been stopped by pressing Timer On/Off.
In case it does not work, even the action is taken as above.	<ul style="list-style-type: none"> • Press the S.Bass button for 5 seconds in power 'OFF'(standby), then it is returned the original position (RESET)
The compact disc player does not start playing	<ul style="list-style-type: none"> • The CD function has not been selected. • The disc has been inserted face down or is either dirty or scratched. • The laser sensor is dirty or dusty. • The system has not been installed on a flat, horizontal surface. • Condensation has formed in the player; leave the system in a warm, airy room for at least one hour.
The mp-3 CD player cannot be played.	<ul style="list-style-type: none"> • Use the PC to confirm if the extension is *.mp3.
The tape does not start playing	<ul style="list-style-type: none"> • The TAPE function has not been selected. • The cassette has not been inserted correctly. • The cassette player has not been closed. • The tape is either slack or broken.
The volume falls off	<ul style="list-style-type: none"> • The audio heads are dirty.
The cassette is not erased correctly	<ul style="list-style-type: none"> • The rollers or drive capstans are dirty.
There is excessive wow and flutter	<ul style="list-style-type: none"> • The tape is worn.
Reception is poor or no radio stations are received at all	<ul style="list-style-type: none"> • The TUNER function has not been selected. • The radio frequency has not been correctly selected. • The aerial has been disconnected or is not facing the right way. Turn it until you find the best orientation. • You are in a building that blocks radio waves; you must use an outside aerial.

If the above guidelines do not allow you to solve the problem, take a note of:

- ◆ The model and serial numbers, normally printed on the rear of the system
- ◆ Your warranty details
- ◆ A clear description of the problem

Then contact your local dealer or SAMSUNG after-sales service.

Technical Specifications

SAMSUNG strives to improve its products at all times. Both the design specifications and these user instructions are thus subject to change without notice.

RADIO

LW(option)

Usable sensitivity 60 dB

SW(option)

Usable sensitivity 40 dB

AM (MW)

Signal/noise ratio 40 dB

Usable sensitivity 54 dB

Total harmonic distortion 2 %

FM

Signal/noise ratio 58 dB

Usable sensitivity 10 dB

Total harmonic distortion 0.6 %

COMPACT DISC PLAYER

Capacity 3 discs

Frequency range 20 Hz - 20 KHz (\pm 1 dB)

Signal/noise ratio 85 dB (at 1 KHz) with filter

Distortion 0.05 % (at 1 KHz)

Channel separation 74 dB

Disc sizes Diameter: 120 or 80 mm. Thickness: 1.2 mm

TAPE DECK

Frequency range 125 Hz ~ 8 KHz

Signal/noise ratio 40 dB

Channel separation 35 dB

Erasing effect 50 dB

AMPLIFIER

Output power (6 Ω) 35 Watts / CH RMS, (total harmonic distortion: 10 %)

Channel separation 45 dB

Signal/noise ratio 75 dB

GENERAL

Dimensions 270 (W) x 317 (H) x 370 (D) mm

THIS APPLIANCE IS MANUFACTURED BY:

